

Design Guide for Humidity and Temperature Sensors

A comment on how to properly design-in an SHTxx or STSxx.

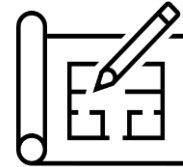
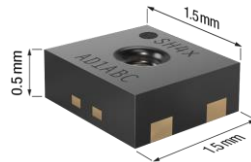

SHTxx are humidity and temperature sensors of highest quality with a broad range of different features. To take full advantage of their outstanding performance, several housing and PCB design rules need to be considered. This document aims to provide help during the design-in phase of your product and fosters a deeper understanding of the sensor's functionality. Please note that unbeneficial housing and/or PCB designs may cause significant temperature and humidity deviations as well as an increased response times.

Most important Design-In Recommendations

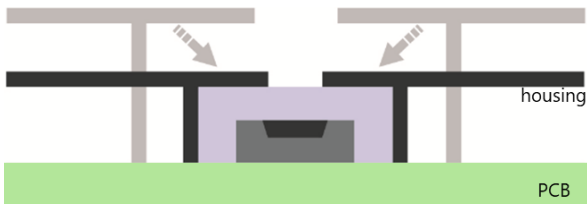

Figure 1. A small dead volume allows for rapid adaption to changes in the environment.



Figure 2. Separating a sensor compartment from the remaining housing minimizes the influence of entrapped air on the sensor.



Figure 3. A large opening in the housing provides improved air exchange and thus enhanced access to the environment.

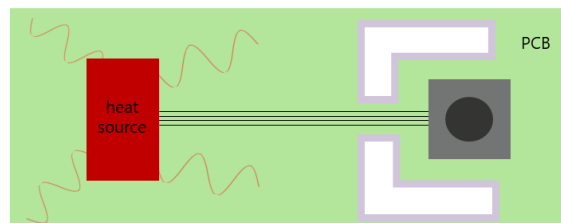

Figure 4. Decoupling of the sensor from heat sources on the PCB minimizes the influence of internal heating on the sensor.

Scan me to provide feedback



Contents

1	Humidity Fundamentals.....	3
1.1	Relative Humidity %RH.....	3
1.2	Dew Point and Condensation	3
2	Sensor Performance	4
2.1	Introduction to Capacitive Humidity Sensing.....	4
2.2	Identifying Measurement Needs	4
2.3	Accuracy of the Sensor vs Accuracy of the System.	4
2.4	Measuring the right thing by measuring at the right place.....	4
2.5	Response Time	5
2.6	Effect of Condensation.....	5
2.7	Creep and Drift.....	5
2.8	Contamination of the Sensor	7
3	Thermal Considerations	8
3.1	Self-Heating.....	10
3.2	Effect of Temperature on the Analog Sensor	10
3.3	Thermal Design-In Conclusion:.....	11
4	Electrical and Signal Considerations	12
4.1	Analog vs. Digital	12
4.2	Electric Specifications	12
4.3	ESD Protection.....	12
4.4	I2C-Related Considerations	13
5	Housing and PCB-Design Integration	14
5.1	Effects on Response Time	15
6	Mounting and Installation.....	16
7	Examples	17
8	Bibliography.....	19
9	Revision History.....	20

1 Humidity Fundamentals

1.1 Relative Humidity %RH

Relative humidity (%RH) is the measure of the amount of moisture in a gas (usually air) relative to the maximum amount that the gas could hold at that temperature. Physically speaking, it is the ratio between the partial pressure of water p_{H_2O} and the corresponding temperature and gas dependent saturation vapor pressure $p_{H_2O,0}$. In the following, and in the great majority of catered applications, the gas is air at atmospheric pressures. Relative humidity is typically expressed as a percentage, where 100 %RH means that the air is saturated and cannot hold any more moisture. RH is significant in different environments because it affects various factors such as human comfort, health, and the growth of organisms. In indoor environments, too low RH levels can cause dry skin, respiratory problems, and static electricity buildup. On the other hand, high RH levels can promote the growth of mold and bacteria, which can lead to health problems. In industrial and manufacturing environments, RH levels can affect the quality of products and processes. For example, in the production of electronic components, high humidity levels can cause corrosion and damage to the components. Furthermore storage of certain products such as food, drugs, and chemicals may require careful control of RH to ensure high quality and longevity. Therefore, measuring humidity is crucial in many different applications. This document should help you to design-in Sensirion’s Humidity and Temperature Sensors into your specific system/device and to illustrate some basic rules that need to be considered.

As indicated, relative humidity is strongly temperature dependent because warm air can hold more moisture than cool air. Therefore, the relative humidity of air changes with the temperature, even when the absolute amount of water vapor in the air (typically called absolute humidity) remains constant.

At constant absolute humidity, two states with different temperatures and relative humidity are related through equation 1:

$$RH_2 = RH_1 \exp\left(m T_n \frac{T_1 - T_2}{(T_n + T_1)(T_n + T_2)}\right) \quad (1)$$

$RH_{1,2}$: Relative humidity at state 1, 2

$T_{1,2}$: Temperature [°C] at state 1, 2

$m = 17.62$

$T_n = 243.21 \text{ } ^\circ\text{C}$

As further reading we recommend having a look at the document “Introduction to Humidity” [1] on Sensirion.com or the “Guide to the Measurement of Humidity” from the National Physical Laboratory [2]. For general Handling Instructions and Specification’s please refer to the datasheet and the documentation on our website.

1.2 Dew Point and Condensation

Condensation can occur on any surface, including windows, walls, and ceilings when the temperature of the air drops below the so-called dew point, causing the water vapor to condense into liquid droplets. In other words, the dew point is the temperature at which air becomes saturated with water vapor (RH=100%), causing condensation at any temperature lower than the dew point. This implies that in an environment of less than 100 %RH there can still be condensation at a surface with a temperature lower than the dewpoint. An example of this is when a bottle of water is taken out of the fridge and condensation forms on the outside. Because the bottle was in the fridge, its cold sidewalls are lower in temperature than the surrounding environment and can therefore be lower than the dew point.

2 Sensor Performance

2.1 Introduction to Capacitive Humidity Sensing

Capacitive humidity sensors measure a change in capacitance using a thin polymer film that absorbs water vapor from the air. As the polymer absorbs moisture, the overall dielectric constant changes due to incorporation of water molecules, which in turn results in a measurable change of capacitance. Typically, this change in capacitance is then converted into a voltage signal proportional to the relative humidity of the surrounding air. Capacitive humidity sensors are highly accurate, durable, and have a fast response time, making them ideal for a wide range of applications in different environments. While analog sensors provide a continuous output signal that varies with the change in relative humidity, digital sensors provide a discrete output signal in the form of binary data that represents the relative humidity value. Digital sensors are typically easier to integrate, certifiable and are subject to less impact from the environment than analog sensors, but they also require additional circuitry for signal processing and calibration. Analog sensors are more robust and simpler to use. Therefore they might be more suitable for some applications. Especially for high noise applications where I2C signals are not stable anymore. Nevertheless the surrounding electronics can influence the analog signal more strongly (see section 4.1).

2.2 Identifying Measurement Needs

Prior to designing-in a capacitive humidity and temperature sensor, one must identify the measurement needs and consider various factors. Firstly, one should assess the desired range of humidity and temperature levels to be measured accurately. This involves understanding the environmental conditions in which the sensor will be deployed and determining the minimum and maximum humidity and temperature values of interest. Secondly, you need to evaluate the required accuracy and precision of the measurements. Depending on the application, a higher level of precision may be necessary, requiring a more sensitive and accurate sensor (see section 2.3). Thirdly, you should consider the response time required for humidity and temperature measurements. And finally, know the expected chemical surroundings in order to evaluate if a membrane or conformal coating is needed. Please note that Sensirion's newest generation of temperature and humidity Sensors are equipped with a heating element. The heating element helps to reduce creep and remove condensation, find the respective information in the Datasheet. The sensor's surrounding and exposure to harsh conditions will define if the heater will be used frequently and thus if there is a need for an increased power supply.

2.3 Accuracy of the Sensor vs Accuracy of the System.

When using a humidity and temperature sensors in a system or device, it is important to remember that the accuracy and performance of the sensors alone do not guarantee the accuracy and performance of the whole system or device. Many external factors, such as the design of the device, external and internal heat sources, airflow, and homogeneity of the air/gas, can affect the accuracy of the system. This guide aims at identifying such influences on the sensor and providing guidelines to decouple the sensor from harmful influences. Nevertheless, real-world applications are tremendously diverse and numerous, which entails that this guide only showcases some important considerations as inspiration yet remains far from complete.

The accuracy specified by Sensirion refers to the stand-alone Sensor and therefore the design-in with all its different aspects will define the accuracy of the final device.

2.4 Measuring the right thing by measuring at the right place.

Representative sampling is an important consideration when designing-in a humidity sensor into a specific device/application. The sensor's local microclimate RH_L should be representative of the overall environmental conditions RH_E (see **Figure 5**). If the sensor is placed in a location that is not representative of the overall environment, the readings it provides may not be accurate. To ensure representative sampling, it is important

to consider the factors that affect the humidity level in the environment, such as temperature, airflow, and the presence of moisture sources. Additionally, it is important to consider the size of the area being monitored and the number of sensors needed to provide an accurate measurement of the overall humidity level. For example, in a large room with varying humidity levels, multiple sensors may be needed to provide an accurate representation of the overall humidity level.

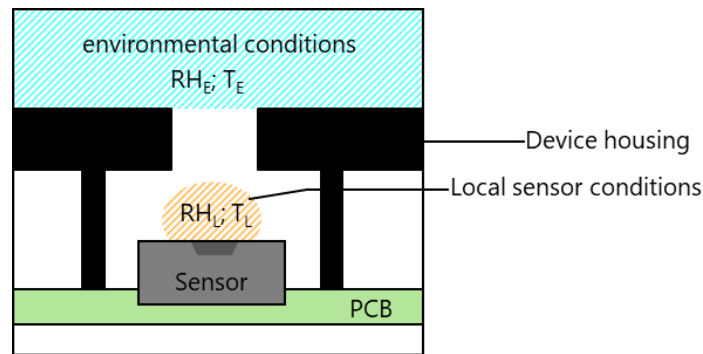

Figure 5. The sensor measures the local conditions at the sensing element (RH_L ; T_L). To achieve good measurements these local conditions need to correspond to the conditions of the environment under test (i.e. RH_E ; T_E).

2.5 Response Time

Response time is a measure of how fast the sensor reading reacts to physical changes in the environment. As the underlying principle for the measurement of humidity and temperature correlates to different physical equilibriums it also implies different response times for each parameter. For the temperature response time, it is the time needed for the sensor to reach thermal equilibrium with its environment. Sensirion Sensors are very small with little thermal mass and thus have a fast response time. The humidity response time is governed by the equilibrium of the relative vapor pressure of the sensor environment with the sensing element itself. The sensing polymer reacts to humidity changes by absorbing or desorbing water proportional to the relative humidity of the environment. Typically, the response time is specified as the sensor’s response to a step function and denoted by τ_{63} , the time which is needed to reach 63% of the step value. In the real world, however, step functions seldomly occur, and the sensor typically is partially housed, making response time considerations slightly less relevant (see section 5.1). For more information, please find the document “Sensor Specification Statement and Testing Guide” [3] on sensirion.com.

2.6 Effect of Condensation

In contrast to many types of humidity and temperature sensors, condensed water has only marginal effects on Sensirion Humidity and Temperature Sensors which still function within given specifications in condensing environments. Nevertheless, please refer to section 2.7 to see, how high humidity levels can contribute to a reversible creep in the sensor reading.

2.7 Creep and Drift

Creep and Drift are terms that describe an offset reading of the actual humidity value. The main difference between creep and drift is the reversibility. Creep is a result of exposure to high temperatures and humidity values, whereas drift comes from alteration over time. ¹

¹ Please note that this explanation is simplified.

To understand the origin, think of the sensing polymer as a porous structure with absorption sites for water molecules. It is in constant equilibrium with the surrounding environment and absorbs and desorbs water molecules corresponding to the relative water vapor pressure of the air. The sensing polymer is designed for most of these absorption sites to be equal in terms of their energy levels and kinetics. As the activation energy for absorption and desorption is generally very low, the sensor works effectively and fast, as illustrated in green in **Figure 6**. However, some absorption sites need a higher activation energy to be occupied or vacated (see **Figure 6** red), which makes them both less likely to be filled when empty and vacated when filled.

When the sensor is exposed to high humidity and temperature levels, the vapor pressure and energy of the water molecules is high enough for them to occasionally start occupying these states leading to a temporary offset, so called creep. Because desorption from these sites is less pronounced the effect of creep may persist over some time. Although the increased energy barrier generally hinders absorption to these sites, high temperature, high humidity, and time increase the absorption probability and therefore creep.

Creep is reversible with time and the process can be accelerated actively. This is why Sensirion sensors come equipped with a heater that helps to vacate these sites by providing thermal energy to the polymer. Please refer to the document "Creep Mitigation" for more information [4]. In addition to the reversible drift, the long-term drift might also contain an irreversible component, originating from altering of the polymer structure. This makes up the irreversible part of the drift that cannot be mitigated with the heater.

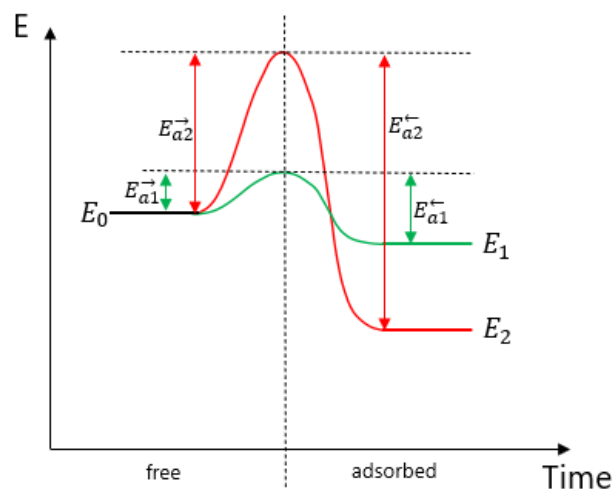

Figure 6. Schematic representation of the energy levels of two different H₂O adsorption sites in the sensing polymer, where the green path represents absorption and desorption (forward and backward reaction) in common states with a low energy barrier and small energy difference between the occupied E_1 and unoccupied E_0 state. The red path represents the same absorption and desorption processes in extraordinary sites, exhibiting a significantly higher energy barrier and a lower energy of the adsorbed state. $E_{a1,2}^{\rightarrow}$ stands for the activation energy needed for a water molecule to adsorb and $E_{a1,2}^{\leftarrow}$ to desorb from the polymer.

This might not have direct implications for the design of a specific application, but we believe that it useful to understand the measurement concept and therefore ease the understanding for other design problems.

Sensirion Definition and Determination of Drift

To meet the worst-case scenario, drift is determined in both directions Sensirion defines it as a widening of our specification over a certain time.

E.g. A drift of <0.1 °C per year implies a widening of the original accuracy specification by a maximum of ± 0.1 °C every year.

2.8 Contamination of the Sensor

Contamination refers to foreign substances whose presence affects the sensor's reading. While contamination must be assessed on a case-by-case basis because of its individual nature, its main effect can be described. Generally, contamination leads to too high %RH readings in dry environments and to too low %RH readings in elevated humidity environments. This behavior is attributed to the difference in the dielectric permittivity of the polymer, water, and potential contaminants, of which water exhibits one of the highest permittivities ($\epsilon=80$) with only very few exceptions.

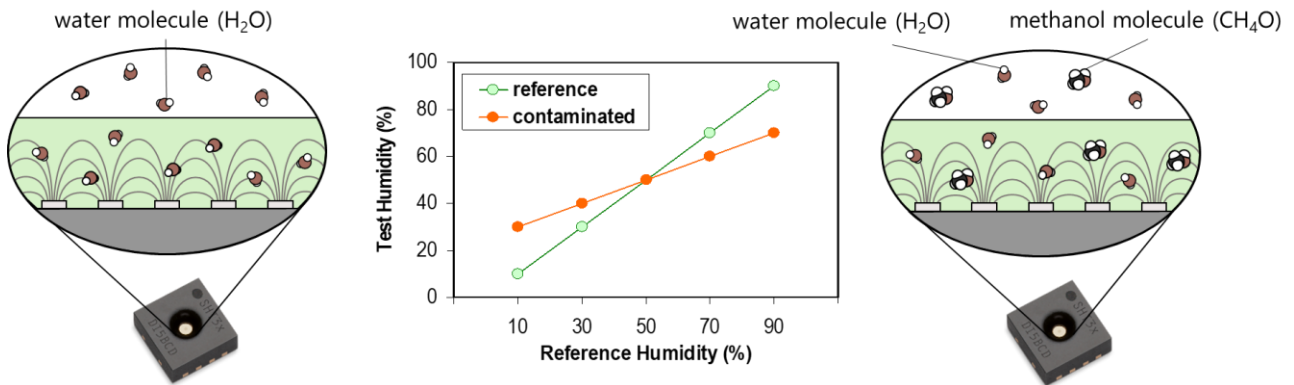

Figure 7. Schematic representation of the difference between a clean (left) and methanol contaminated sensor (right). The measurement results in the middle show how the offset is different at low and high %RH level.

As illustrated in **Figure 7** the offset due to contamination at low %RH results in too high readings. The contaminant occupies adsorption sites in the polymer that would otherwise be empty and increases the dielectric permittivity of the whole system. At high %RH the contaminant is in competition with the water molecules and occupies adsorption sites that would otherwise be occupied by the water molecules. As water has a very high dielectric permittivity the contaminant lowers the overall dielectric permittivity regarding the state without contamination.

For more detailed information on the different types of contamination and their effects, mitigation, recovery as well as guidelines regarding handling which are specific to contamination, please refer to the "Contamination Guide" from Sensirion.com

3 Thermal Considerations

As mentioned in section 1.1 the relative humidity is strongly temperature dependent. External heat sources close to the sensor will cause increased temperature (and thus decreased RH) readings. In extreme cases such as at 90 %RH, a deviation of 1 °C will result in a deviation of the humidity signal of 5 %RH. Therefore, the influence of external heat sources in the proximity of the sensor needs to be kept at a minimum for accurate measurements. In order to know how to thermally insulate the sensor from the rest of the device it is useful to think about the main transport phenomena of heat. The thermal equilibrium with its surrounding is controlled via conduction and convection, therefore the following points should be considered to avoid heating:

- Heat conduction: The sensor should be thermally decoupled from all heat sources and coupled to the environment as much as possible.
- Heat convection/radiation: Shield the sensor from heated air and heat radiation.

Heat conduction from nearby heat sources (power electronics, microprocessors, displays, *etc.*) is the more severe and most common source of temperature deviations. Mostly it occurs through the PCB and can be mitigated by sufficient distances and removal of unnecessary metal around the sensor (*e.g.* through milling or etching slits as shown in **Figure 8**). To mitigate the risk of unwanted temperature deviations it is beneficial to keep metal connections on the PCB as thin as possible. A possible workaround is to use our sensor mounted on a flex PCB which significantly reduces the heat conduction.

Regarding heat convection and radiation, the first solution is to keep potential heat sources as far away from the sensor as possible and to consider the direction of airflow through the device. The sensor should not be exposed to heated air from other electronic components. Therefore it is recommended to physically shield the sensor from its surroundings with walls which also improves the performance by minimizing dead volume as shown in **Figure 9**.

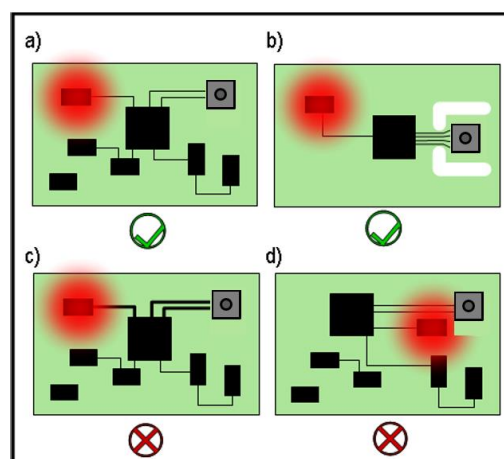

Figure 8. a) Thin metal connections and sufficient distance to the heat source helps minimize heat conduction. b) The milled slits (white lines) around the sensor decrease the thermal conduction through the PCB. c) Unnecessary metal, such as thick metal connections will increase heat transfer from the heat source to the sensor. d) Heat sources in close proximity will heat the sensor excessively.

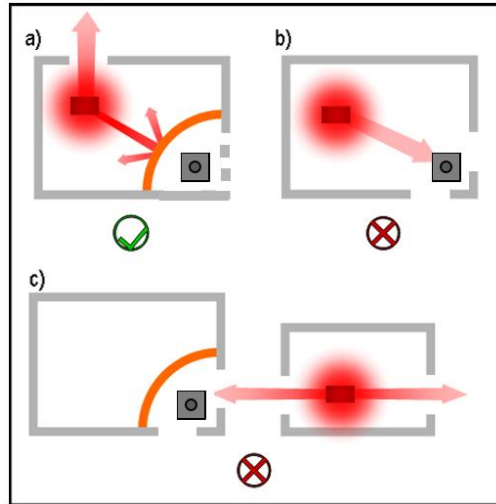

Figure 9. a) A wall (orange) shields the sensor from the heated air. The opening on the top avoids the heating of the complete housing. b) The heated air gets in direct contact with the sensor which will cause increased temperature readings. c) Even heated air from nearby devices may influence the sensor readings

3.1 Self-Heating

All electronic devices are prone to self-heating, which depends on the used components, the build, and the mode in which it is operated. For example, during charging or when operated in a high-power consumption mode (e.g. maximal screen brightness) self-heating is increased. Nevertheless, this issue can easily be overcome by smart thermal design-in, potentially coupled with an algorithmic compensation of the residual offset. For illustration, see **Figure 10**, which shows the effect of self-heating in an exemplary device with good (green) and bad (red) design-in.

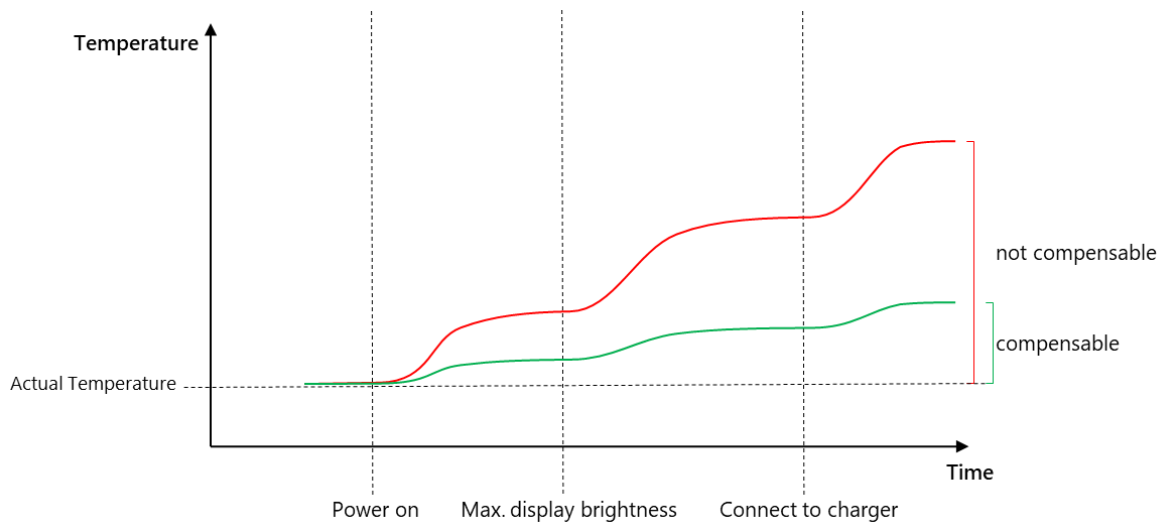

Figure 10. Schematic comparison of the effect of self-heating in a good (green) and bad (red) thermal design-in. The dashed lines indicate a mode change which results in a temperature increase. Please note that the temperature increase of the individual components is the same, the only difference comes from the design-in of the sensor and therefore what the sensor feels. The first temperature increase is the so-called basic heat up. The second dashed line represents the mode change to maximum brightness, but it could also be due to other components e.g. the CPU. The last dashed line shows the effect that comes from charging a device with an implemented humidity and temperature sensor.

Kindly note that even with an immaculate design-in there might be a residual effect of the self-heating on the sensor. This small disturbance can be compensated via an algorithmic solution. Please note that subsequent compensation of temperature also requires a compensation of the RH signal as the RH is strongly temperature dependent.

Component level self-heating can be significant for analog sensors. For considerations regarding analog sensor self-heating please refer to section 3.2.

3.2 Effect of Temperature on the Analog Sensor

Analog sensors are more prone to component level self-heating, which requires some additional considerations. In such cases, having good thermal coupling between the sensor and the PCB as well as sufficient thermal mass around the sensor decreases self-heating effects. As presented in section 3, such a design comes with an increase in response time. The trade-off between response time and self-heating regarding thermal mass and thermal coupling should be considered when designing-in an analog sensor.

Analog signals are prone to interference by nearby electronics or heat sources within the device. For example, through induced changes of resistance, which influences the analog signal. In the case of analog

SHT sensors, the signal is a voltage output, which may be disturbed by factors such as noise, interference, and environmental conditions prior to digital conversion. For example, heat changes the resistivity of the wires through which the signal is transported and therefore affects the potential, resulting in a change of the apparent %RH reading. In contrast, a digital signal, once generated, is typically immune to such variations as it is based on discrete values, allowing for more robust and reliable transmission as well as storage of information. However, it's worth noting that even digital signals can be subject to errors if there are issues with the transmission or decoding process.

3.3 Thermal Design-In Conclusion:

Thermal coupling to the environment is desired while thermal coupling to the rest of the device should be avoided. In particular, the sensor needs to be decoupled from the thermal mass of the device and shielded from any heated air flowing through it (see **Figure 8**, **Figure 9** & **Figure 11**). As a rule of thumb, the sensor should be implemented as isolated as possible and as exposed to the environment as possible. In the best case with a flow of ambient air around the sensor. Additionally, ensure that the heat transfer away from the device itself is guaranteed and optimized as much as possible. Depending on the final location it is used/installed, *e.g.* wall, floor, table, the heat conduction will differ. It is important to avoid heating the complete system and be aware that the analog sensor signal is even more sensitive to interferences prior to the ADC (see section 4.1).

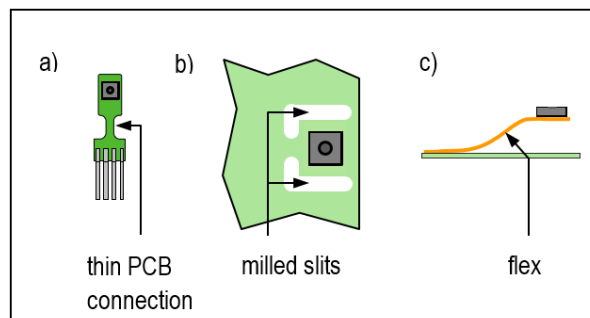

Figure 11. The sensor may be thermally decoupled from the PCB by small PCB connections or with a flex.

4 Electrical and Signal Considerations

4.1 Analog vs. Digital

Most applications today profit largely from or even demand the use of digital solutions. We therefore recommend the use of our newest generation SHT4x Digital Sensor and only refer to analog versions if specific applications must be designed analog. In those cases, it is important to consider the thermal considerations regarding signal transmission and self-heating explained in sections 3.1 and 3.2.

4.2 Electric Specifications

When incorporating a humidity and temperature sensor, it is necessary to check the electric specifications according to the sensor datasheet. Even though Sensirion’s sensors have an ultra-low power consumption a stable power supply is needed. Sensirion’s SHT4x sensors come equipped with an integrated heater for creep mitigation, decontamination, and general testing. Heater use frequency needs to be considered, as frequent use increases the power consumption according to the electrical specifications in the sensor datasheet. Battery powered applications, as for example RHT trackers, should be designed to avoid heater use in order to minimize power consumption.

4.3 ESD Protection

During sensor handling, the sensor shall be protected from ESD (Electrostatic Discharge) and the assembly process itself should incorporate ESD control measures. This includes ensuring proper grounding, using antistatic packaging and materials, and employing ESD-safe workstations and tools. More about ESD and guidelines can be found in the “Handling Instructions” [5].

After the sensor is mounted in the device, the risk of ESD is slightly reduced, however, basic ESD protection measures and the following recommendations should still be applied. Make sure that the sensor cannot be reached by hand. As exposure of the sensor is otherwise desired, a potential workaround can be to cover the sensor with a wide-meshed metallic wire enclosure creating a faraday cage (as showed in **Figure 12**).

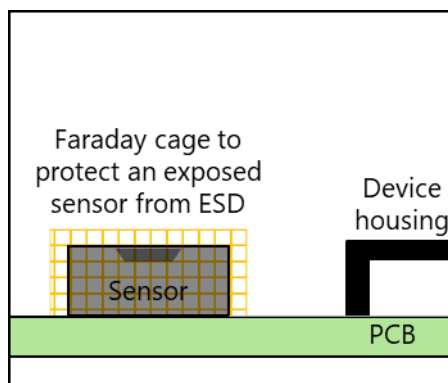

Figure 12. An exposed sensor with no protection provided by the device housing might be covered through a Faraday cage e.g. a wide-meshed metallic wire enclosure (yellow).

4.4 I2C-Related Considerations

Sensirion SHTxx Sensors rely on the I2C (Inter-Integrated Circuit) communication protocol [6]. I2C is a widely used serial communication protocol that allows multiple devices to communicate with each other using a shared bus. It uses two bidirectional lines: SDA (Serial Data Line) for data transmission and SCL (Serial Clock Line) for clock synchronization. Find more information in the respective datasheets.

Regarding the Design of a new device, there are some I2C-related factors to consider:

Noise:

To minimize noise interference of other signals, make sure to have all devices on the I2C bus properly grounded sharing a common ground connection. Signal integrity can also be enhanced by using high-quality cables and connectors, keeping the traces short and avoiding sharp bends. At high exposure to electromagnetic interference, it might be beneficial to shield the PCB and use shielded cables.

Cable Length

I2C is designed for short-distance communication within a single PCB or between devices on the same board. I2C cables ideally should be as short as possible. This reduces the cables' parasitic capacitance. Long cable lengths can lead to signal degradation and may require signal buffering or repeaters. If long cable lengths are necessary, consider using I2C bus extenders or I2C isolators to maintain signal integrity and protect against noise. If none of the above is possible, and high noise can be expected in the system, the analog versions of SHT can be a suitable alternative.

Multicomponent System

I2C allows multiple components to share the same bus, reducing the number of communication lines required. This can lower the pin count on microcontrollers and other devices, potentially reducing costs and board space needed. This is possible as I2C uses a controller(master)-target(slave) architecture, enabling efficient data transfer between multiple devices on the same bus. When multiple components are on the same bus each device on the I2C bus must have a unique address. Sensirion SHTxx Sensors are available with three different I2C addresses (0x44, 0x45 and 0x46) which allows easy integration of multiple sensors on the same I2C bus. Having multiple devices with the same address can lead to conflicts and communication errors.

Clock Stretching

Some I2C devices may need additional time to process data, resulting in clock stretching. Ensure that the master device as well as the sensor can handle clock stretching to avoid data corruption.

5 Housing and PCB-Design Integration

As mentioned in section 2.4 it is important to make sure that the measurements of the sensor are representative of the environment of interest. Furthermore, the effect on response time needs to be considered during the design phase.

Design with a Possible Airflow

If there is airflow over the sensor (see **Figure 13 a**), the air inside of the dead volume is exchanged constantly. Such a design-in is favourable in terms of response times. Even if there is no defined flow (e.g. in a living room) a device designed with multiple openings and possible airflow is preferred. If there is no possibility to realize a design with airflow directly over the sensor, the following points become more important.

Dead Volume

The larger the dead volume, the more air needs to be exchanged until the environmental and sensor conditions match each other. Large dead volumes will drastically increase the humidity response time. It is recommended to keep the dead volume as small as possible by compartmentalization as seen in **Figure 13 b** and c.

Aperture Size

The aperture is the connection between environment and sensor. A larger aperture allows for faster exchange of air and therefore better humidity response times. Nevertheless, for harsh conditions a trade-off between exposure and response times needs to be made.

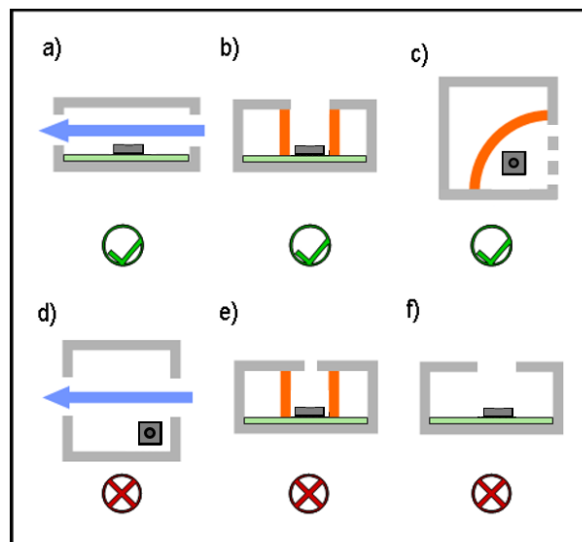

Figure 13. Schematic view of different design-ins. a) The defined airflow goes directly over the sensor and therefore the local conditions at the sensor equilibrate quickly with the environmental conditions. If there is no defined flow this design is not recommended as the dead volume is too big. b) The walls (orange) reduce the dead volume which in combination with the large aperture will lead to good response times. c) The small dead volume, and multiple openings enable good air exchange. d-f) These designs will have slow humidity response times due to the following reasons: d) The airflow misses the sensor, and the dead volume is large. e) The aperture size is too small with respect to the dead volume. f) The dead volume is large.

5.1 Effects on Response Time

To get a feeling how the housing affects the response time take a look at **Figure 14** from the Sensirion Github Article, SHT4x Smart gadget housing ([GitHub - Sensirion/smartgadget-sht4x-housing: Housing for the SHT4x Smartgadget](#)). The main takeaway is that a correctly designed housing does not affect the accuracy of the sensor. However, as soon as the sensor is mounted, meaning that it is coupled to a bigger thermal mass, the humidity and temperature response time is affected, even when it is only soldered to a PCB without an actual housing covering the sensor. It also illustrates that a big aperture has a smaller effect than the connected thermal mass. The humidity response time at constant temperature is very fast but lengthens with fluctuating temperature due to the strong coupling of RH to temperature.

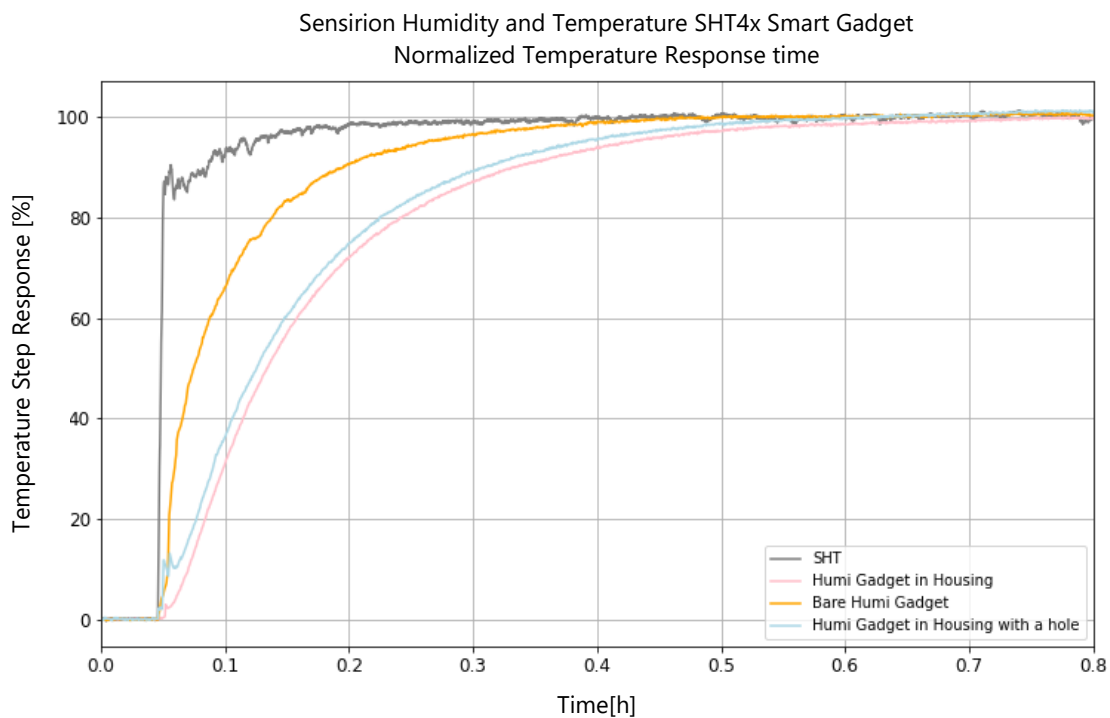

Figure 14. Difference of a standalone sensor (black), a sensor mounted on the gadget with no housing (yellow), a sensor mounted on the gadget with housing (pink), and a sensor mounted on the gadget with housing and a hole (blue).

6 Mounting and Installation

This section should help you select what type of packaging is best suited for your device and what decisions need to be taken during the design-in. The standard SHTxx are provided in an open-cavity dual flat no lead (DFN) package with the following optional features:

- **Filter Membrane:** The filter membrane protects the sensor opening from water and dust according to IP67. Due to the minimal package volume and the membrane's high vapour permeability, the response time is identical to the sensor without membrane (see **Figure 15**).
- **SF2 Filter membrane:** The SF2 Filter membrane is a free-standing filter membrane that can be used to protect the sensor and housing opening against water, dust, soot, particles, and other contaminants. It seals a housing towards the environment, not only the sensor opening. The cavity inside the cap is designed so that the dead volume between membrane and sensor is negligible (see **Figure 15**); hence the impact on response time for humidity measurements is reduced to a minimum.



Figure 15. SHT4x with the integrated filter membrane option on the left and on the right the free standing SF2 filter membrane.

- **Protective Cover:** The protective cover is meant to protect the sensor during mounting. After processing and before operation the protective cover must be removed from the sensor. The cover is particularly recommended for processes like conformal coating of the corresponding PCB. Conformal coating is a protective layer applied to electronic circuitry to enhance the reliability and durability of a device. The protective cover is slightly larger than the sensor (see **Figure 16**) in order for it to safely be removed using the designated non-sticking flap. Kindly consider the dimensions in the respective datasheet to see if the protective cover option is feasible for your desired design.
- **Wettable Flanks:** Wettable flanks facilitate easier and more reliable soldering during the assembly process. The increased surface area allows for better wetting of solder, resulting in stronger and more consistent solder joints. This can reduce the risk of solder defects, such as poor adhesion, voids, or incomplete wetting, which could lead to electrical connectivity issues or mechanical failures. The main advantage is that it facilitates easier inspection after mounting. Regarding the design-in, there are no additional considerations needed compared to the standard DFN package (see **Figure 16**).



Figure 16. Left: SHT4x protective cover option. Right: SHT4xA (automotive grade) with wettable flanks.

- **Mounted on FPCB:** There is the option to mount the sensor onto a Flex-PCB which minimizes thermal conduction from the device to the sensor and allows for easy exchange of the sensor. This can be

useful for devices with an expected lifetime longer than the lifetime of the sensor which is qualified to be 15 years². Sensirion offers FPCP-mounted humidity and temperature sensors for certified devices that incorporate a certified SHT43. This is because certified sensors might be exchanged more frequently. For more information, please refer to the Document Certified Smart tracking [7].

7 Examples

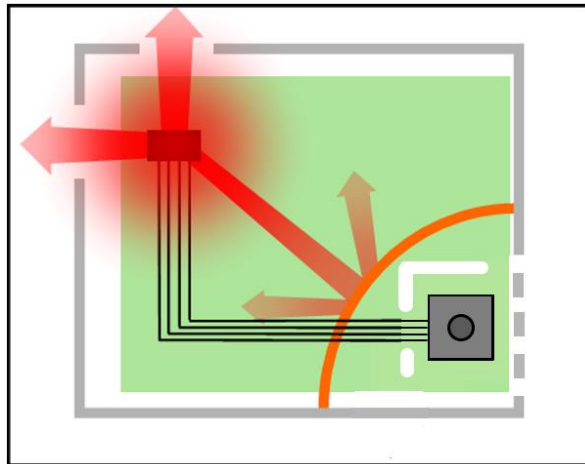

Figure 17. This is the most recommended design-in if no filter membrane is required. It combines the rules above well. The wall (orange) helps to shield the sensor from the heated air as well as decrease dead volume. The large opening on the top left corner allows for good air exchange and reduces self-heating of the whole device. The milled slits around the sensor reduce thermal conduction through the PCB. Additionally, the sensor’s exposure and air exchange with the environment is guaranteed by several slits in the housing that simultaneously act as protection. This design-in provides fast response times as well as low influences from heating parts.

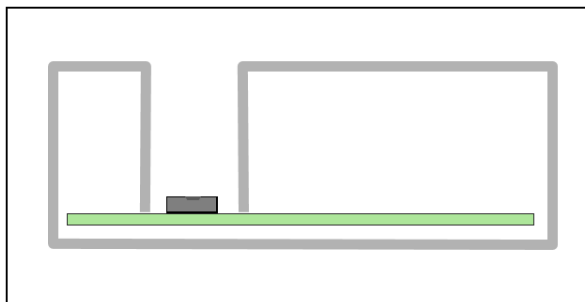

Figure 18. This is a simpler variation of **Figure 17**. As there is no airflow the humidity response time is slower (depending on the distance of the sensor to the opening). With additional slits in the PCB, the sensor could be shielded from external heating if required.

² THB-test, JESD22-A101 Standard

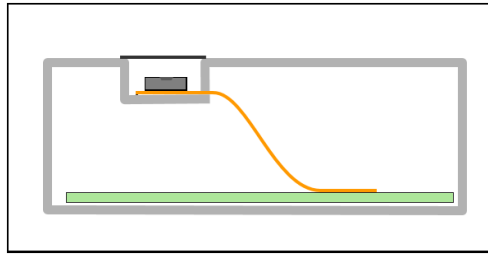

Figure 19. This is a more sophisticated version of **Figure 18** using a flex PCB for thermal decoupling. Additionally, there is a filter membrane to protect the sensor. The short distance between the sensor and the environment under test improves response times.

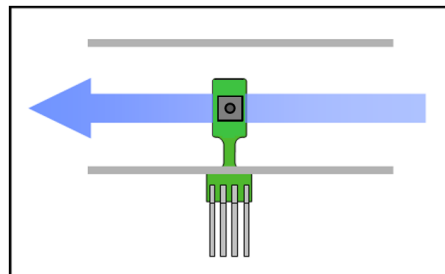

Figure 20. This design shows an SHT85 inside of a tube with airflow. The thin PCB connection decouples the SHT85 very well from the tube and allows very fast thermal response times as well as reducing the influence of temperature deviations between the tube and the air.

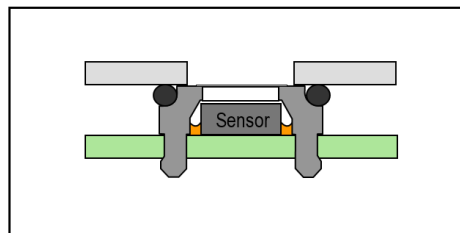

Figure 21. The SF2 filter cap may help to design tight housings. The filter membrane protects the sensor and the housing from dust and water. Due to the small volume between the sensor and the environment, fast humidity response times can be achieved.

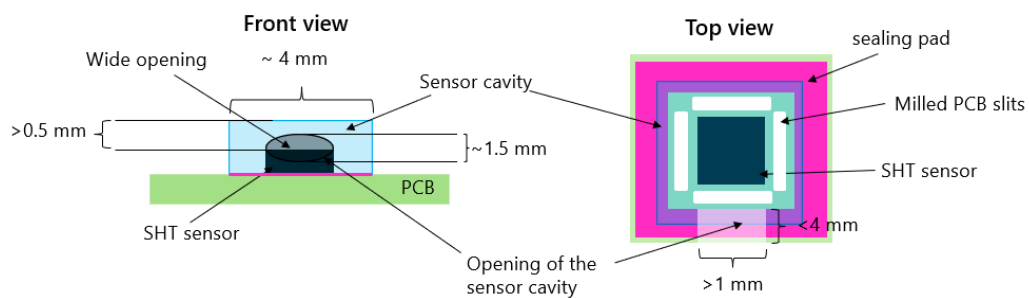

Figure 22. Exhaustive Design-In example showing several important aspects in a specific use case where the sensor needs to be decoupled from the rest of the device achieved by a sensor cavity (blue) with a lateral opening (grey). The PCB (green) has slits (white) around the SHT Sensor to reduce heat conduction. On top of

the PCB, a sealing pad (pink) is mounted as a sealing material to avoid leakage of air and to mount the sensor cavity.³

8 Bibliography

- [1] Sensirion, "Introduction to Humidity," January 2009. [Online]. Available: <https://sensirion.com/products/downloads/>.
- [2] National Physical Laboratory, "https://www.npl.co.uk/special-pages/guides/a-guide-to-the-measure-of-humidity-gpg103," 1996. [Online]. Available: <https://www.npl.co.uk/special-pages/guides/a-guide-to-the-measure-of-humidity-gpg103>.
- [3] Sensirion, "Sensors Specification Statement and Testing Guide," 19 April 2021. [Online]. Available: <https://sensirion.com/products/downloads/>.
- [4] Sensirion, "Creep Mitigation SHT4x," 04 2022. [Online]. Available: https://sensirion.com/media/documents/A88858C9/629626D4/Application_Note_Creep_Mitigation_SHT4x.pdf.
- [5] Sensirion, "Handling Instructions for Humidity Sensors," 2020. [Online]. Available: www.sensirion.com.
- [6] NXP Semiconductors, "User manual UM10204," vol. Rev. 6, 2014.
- [7] Sensirion, "Certified Smart Tracking," August 2023. [Online]. Available: www.sensirion.com.
- [8] IEEE, "IEEE Reference Guide," 2018. [Online]. Available: <https://ieeauthorcenter.ieee.org/wp-content/uploads/IEEE-Reference-Guide.pdf>. [Accessed 20 1 2023].
- [9] Sensirion, "Using the Integrated Heater of SHT4x for Heat-Assisted Polymer," [Online]. Available: https://admin.sensirion.com/media/documents/FEE9F039/62459F54/Application_Note_Heater_Decontamination_SHT4xX.pdf.

³ The size specifications can help to get a feeling for your design-in, should you have different sizing does not mean it does not work.

9 Revision History

Date	Version	Pages	Changes
June 2010	1.0	all	Initial release
May 2019	1.1	1	Updated front page and figures
March 2024	2	All	Complete Remake

Important Notices

Warning, Personal Injury

Do not use this product as safety or emergency stop devices or in any other application where failure of the product could result in personal injury. Do not use this product for applications other than its intended and authorized use. Before installing, handling, using or servicing this product, please consult the data sheet and application notes. Failure to comply with these instructions could result in death or serious injury.

If the Buyer shall purchase or use SENSIRION products for any unintended or unauthorized application, Buyer shall defend, indemnify and hold harmless SENSIRION and its officers, employees, subsidiaries, affiliates and distributors against all claims, costs, damages and expenses, and reasonable attorney fees arising out of, directly or indirectly, any claim of personal injury or death associated with such unintended or unauthorized use, even if SENSIRION shall be allegedly negligent with respect to the design or the manufacture of the product.

ESD Precautions

The inherent design of this component causes it to be sensitive to electrostatic discharge (ESD). To prevent ESD-induced damage and/or degradation, take customary and statutory ESD precautions when handling this product. See application note "ESD, Latchup and EMC" for more information.

Warranty

SENSIRION warrants solely to the original purchaser of this product for a period of 12 months (one year) from the date of delivery that this product shall be of the quality, material and workmanship defined in SENSIRION's published specifications of the product. Within such period, if proven to be defective, SENSIRION shall repair and/or replace this product, in SENSIRION's discretion, free of charge to the Buyer, provided that:

- notice in writing describing the defects shall be given to SENSIRION within fourteen (14) days after their appearance;
- such defects shall be found, to SENSIRION's reasonable satisfaction, to have arisen from SENSIRION's faulty design, material, or workmanship;
- the defective product shall be returned to SENSIRION's factory at the Buyer's expense; and
- the warranty period for any repaired or replaced product shall be limited to the unexpired portion of the original period.

This warranty does not apply to any equipment which has not been installed and used within the specifications recommended by SENSIRION for the intended and proper use of the equipment. EXCEPT FOR THE WARRANTIES EXPRESSLY SET FORTH HEREIN, SENSIRION MAKES NO WARRANTIES, EITHER EXPRESS OR IMPLIED, WITH RESPECT TO THE PRODUCT. ANY AND ALL WARRANTIES, INCLUDING WITHOUT LIMITATION, WARRANTIES OF MERCHANTABILITY OR FITNESS FOR A PARTICULAR PURPOSE, ARE EXPRESSLY EXCLUDED AND DECLINED.

SENSIRION is only liable for defects of this product arising under the conditions of operation provided for in the data sheet and proper use of the goods. SENSIRION explicitly disclaims all warranties, express or implied, for any period during which the goods are operated or stored not in accordance with the technical specifications.

SENSIRION does not assume any liability arising out of any application or use of any product or circuit and specifically disclaims any and all liability, including without limitation consequential or incidental damages. All operating parameters, including without limitation recommended parameters, must be validated for each customer's applications by customer's technical experts. Recommended parameters can and do vary in different applications.

SENSIRION reserves the right, without further notice, (i) to change the product specifications and/or the information in this document and (ii) to improve reliability, functions and design of this product.

Headquarters and Subsidiaries

Sensirion AG

Laubisruetistr. 50
CH-8712 Staefa ZH
Switzerland

phone: +41 44 306 40 00
fax: +41 44 306 40 30
info@sensirion.com
www.sensirion.com

Sensirion Taiwan Co. Ltd

phone: +886 2 2218-6779
info@sensirion.com
www.sensirion.com

Sensirion Inc., USA

phone: +1 312 690 5858
info-us@sensirion.com
www.sensirion.com

Sensirion Japan Co. Ltd.

phone: +81 45 270 4506
info-jp@sensirion.com
www.sensirion.com/jp

Sensirion Korea Co. Ltd.

phone: +82 31 337 7700~3
info-kr@sensirion.com
www.sensirion.com/kr

Sensirion China Co. Ltd.

phone: +86 755 8252 1501
info-cn@sensirion.com
www.sensirion.com/cn

To find your local representative, please visit
www.sensirion.com/distributors